

LARGE SIZE CNC LATHE ANC. TNC. SERIES

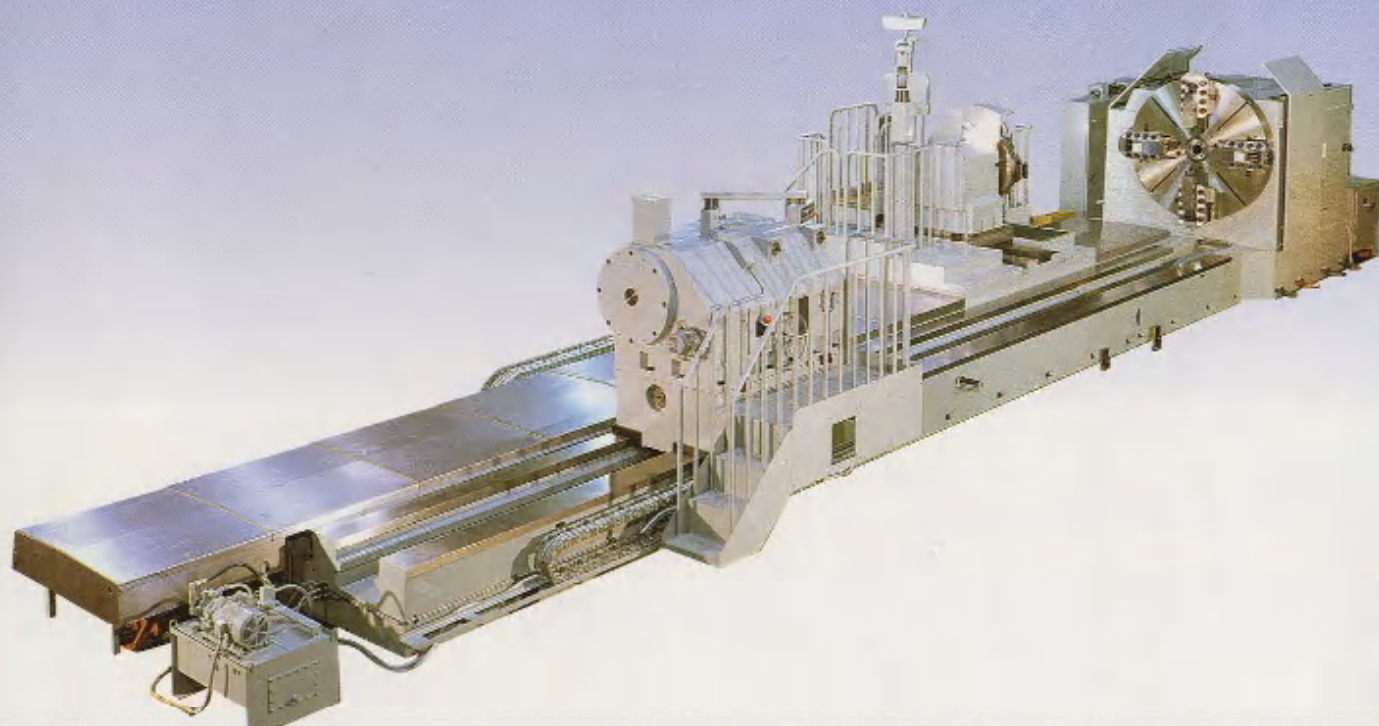

IKEGAI
*Rich Green on Land
Deep Blue in Sky and Sea*

KYOWA, LTD., JAPAN

Main Specifications For Large Size CNC Lathes

		ANC		
		56	75	100
CENTER HEIGHT				
Over bed	mm(°)	560(22)	750(30)	1000(40)
Over floor	mm(°)	1315(52 ¹ / ₂)	1380(54 ¹ / ₂)	1630(65)
SWING				
Over bed	mm(°)	1120(44)	1500(59)	2000(78 ²³ / ₃₂)
Over carriage	mm(°)	800(31 ¹ / ₂)	1050(41 ¹ / ₂)	1550(61)
CAPACITY				
Max. supportable weight between centers	kg(lbs)	5000(11000)	15000(33000)	25000(55000)
Max. supportable weight on chuck	kg(lbs)	1200(2640)	3000(6600)	4000(8800)
Max. cutting force	kg(lbs)	2000(4400)	3000(6600)	4000(8800)
Max. spindle torque	N—m	8000	21000	33000
MAIN SPINDLE				
Spindle nose		JIS A2 NO.11	JIS A2 NO.20	
Front bearing I. D.	mm(°)	180(7 ¹ / ₁₆)	280(11)	320(12 ¹³ / ₃₂)
Hole through dia.	mm(°)	102(4)		
Taper hole		MT NO.6	φ 100 (4) TAPER 1/10	
Spindle speed range (Infinitely variable)	min ⁻¹	4 Ranges 10—1000	2 Ranges 2.5—250	4 Ranges 1.6—185
Chuck (4 Jaw independent)		φ 810(31 ²⁹ / ₃₂)	φ 1250(49 ¹ / ₄)	φ 1600(63)
BED				
Figure & NO. of guideways		HORIZONTAL FLAT · 2		
Width × Height	mm(°)	740×730(29×28 ¹¹ / ₁₆)	1000×630(40×24 ¹³ / ₁₆)	1400×630(55×24 ¹³ / ₁₆)
TRAVEL DISTANCE				
X axis	mm(°)	660(26)	800(31 ¹ / ₂)	1000(40)
Z axis	mm(°)	Center distance + 160(6 ³ / ₈)	Center distance + 100(4)	
RAPID TRAVERSE				
X axis	m/min(°/min)	5(200)	2(80)	
Z axis	m/min(°/min)	10(400)	4(160)	
Tailstock	m/min(°/min)	Moved by carriage	2(80)	1.6(64)
TAILSTOCK				
Type of spindle		Dead center type	Built-in type	
Quill dia. x stroke	mm(°)	φ 160×300(6 ⁵ / ₁₆ ×12)	φ 260×350(10 ¹ / ₄ ×14)	φ 320×400(12 ¹ / ₂ ×16)
Nose taper		MT. NO. 6	φ 80 (3 ¹ / ₈) TAPER 1/10	φ 100 (4) TAPER 1/10
Spindle dia	mm(°)	110(4 ³ / ₈)	150(6)	180(7 ¹ / ₈)
TURRET				
Type		8 Stations Auto. index	Square Auto. index	
Clamping force	kg(lbs)	10000(22000)	13500(29700)	15000(33000)
MOTOR OUTPUT	kw(HP)	AC 37/45(50/60)		
MACHINE WEIGHT	kg(lbs)	14000/CD 4M(30800/CD160)	24000/CD 4M(52800/CD160)	31000/CD 4M(68200/CD160)
CENTER DISTANCE	mm(°)	1000~7000(40~280)	1000~7000. Use of accurated rack for feed in case of longer than 8000	

		TNC		
		56	75	100
CENTER HEIGHT				
Over bed	mm(°)	610(24)	750(30)	1000(40)
Over floor	mm(°)	1240(49 ¹ / ₂)	1380(54 ¹ / ₂)	1630(65)
SWING				
Over bed	mm(°)	1220(48)	1500(59)	2000(78 ²³ / ₃₂)
Over carriage	mm(°)	820(32 ⁹ / ₃₂)	1200(47 ¹ / ₄)	1600(63)
CAPACITY				
Max. supportable weight between centers	kg(lbs)	7000(15400)	15000(33000)	25000(55000)
Max. supportable weight on chuck	kg(lbs)	1500(3300)	3000(6600)	4000(8800)
Max. cutting force	kg(lbs)	3500(7700)	4000(8800)	5000(11000)
Max. spindle torque	N—m	13000	21000	33000
MAIN SPINDLE				
Spindle nose		JIS A2 NO.15	JIS A2 NO.20	
Front bearing I. D.	mm(°)	200(7 ⁷ / ₈)	280(11)	320(12 ¹⁹ / ₃₂)
Hole through dia.	mm(°)			
Taper hole		φ 80 (3 ¹ / ₈) TAPER 1 ¹ / ₁₀	φ 100 (4) TAPER 1 ¹ / ₁₀	
Spindle speed range (Infinitely variable)	min ⁻¹	2 Ranges 4—400	2 Ranges 2.5—250	4 Ranges 1.6—185
Chuck (4 Jaw independent)		φ 810(31 ²⁹ / ₃₂)	φ 1250(49 ¹ / ₄)	
BED				
Figure & NO. of guideways		HORIZONTAL FLAT - 3		
Width X Height	mm(°)	1200X630(48X24 ¹³ / ₁₆)	1500X630(60X24 ¹³ / ₁₆)	1700X630(68X24 ¹³ / ₁₆)
TRAVEL DISTANCE				
X axis	mm(°)	440(17 ³ / ₈)	500(20)	630(24 ¹³ / ₁₆)
Z axis	mm(°)	Center distance + 100(4)		
RAPID TRAVERSE				
X axis	m/min(°/min)	3(120)	2(80)	2(80)
Z axis	m/min(°/min)	6/CD5,5/CD6~(240/CD200,200/CD240~) 4(160)		
Tailstock	m/min(°/min)	2(80)		
TAILSTOCK				
Type of spindle		Built-in type		
Quill dia. x stroke	mm(°)	φ 200X250(8X10)	φ 260X350(10 ¹ / ₄ X14)	φ 320X400(12 ¹ / ₂ X16)
Nose taper		MT.NO.6	φ 80 (3 ¹ / ₈) TAPER 1 ¹ / ₁₀	φ 100 (4) TAPER 1 ¹ / ₁₀
Spindle dia.	mm(°)	110(4 ³ / ₈)	150(6)	180(7 ¹ / ₈)
TURRET				
Type		Square Auto. index		
Clamping force	kg(lbs)	13500(29700)	13500(29700)	15000(33000)
MOTOR OUTPUT kw(HP) AC 37/45(50/60)				
MACHINE WEIGHT	kg(lbs)	22000/CD 4M(48400/CD160)	32000/CD 4M(70400/CD160)	42000/CD 4M(92400/CD160)
CENTER DISTANCE	mm(°)	3000 ~ 7000(120~280) Use of accurated rack for feed in case of longer than 8000		

ANC100 CNC LATHE

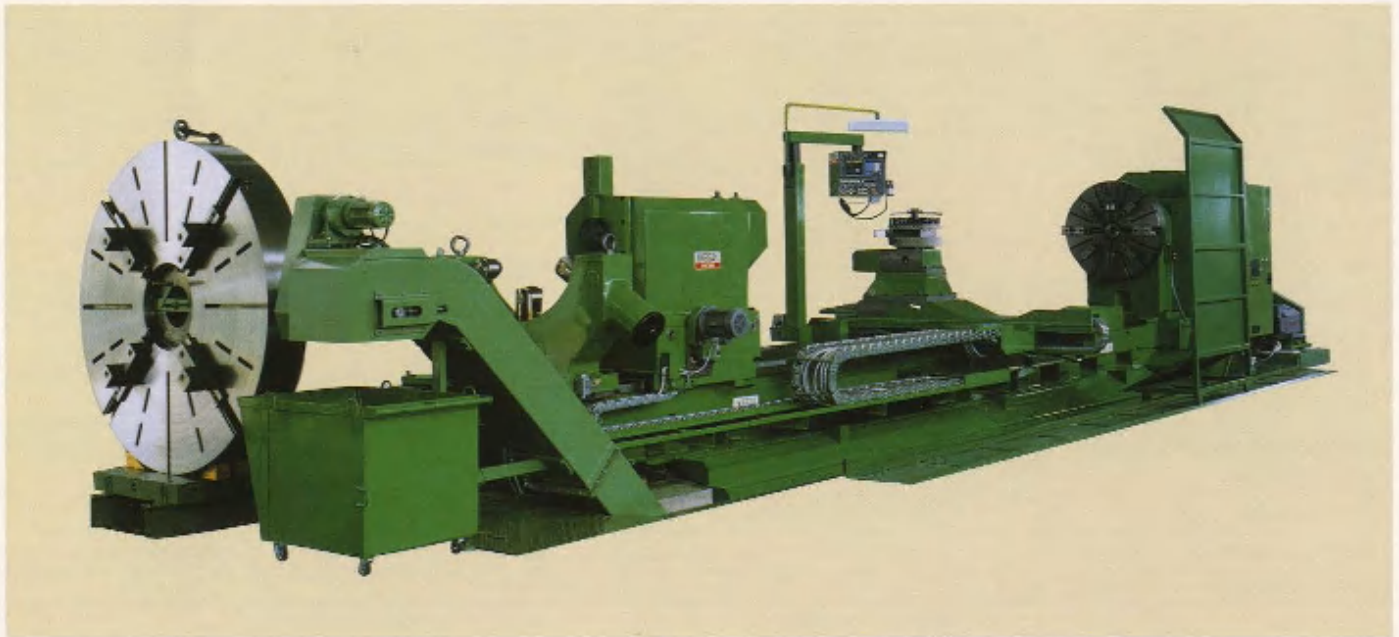

Main Spindle Torque Diagram

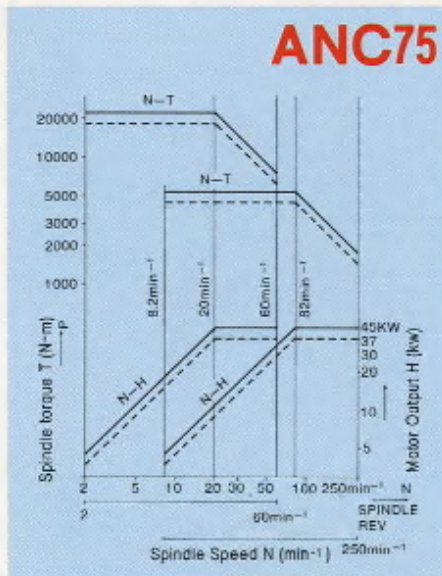

Main Spindle Torque Diagram

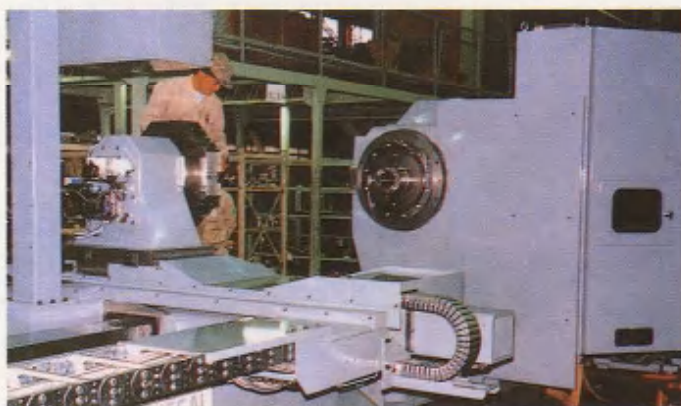
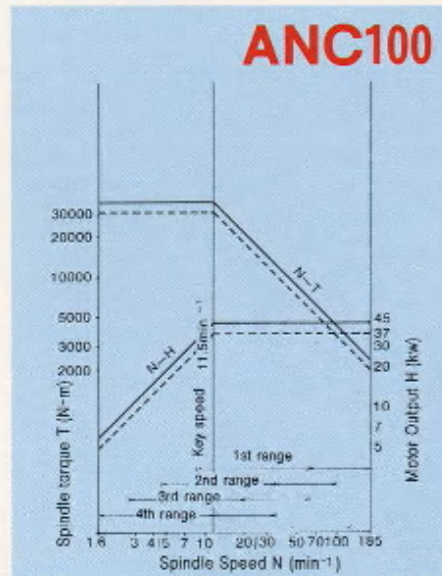

Headstock

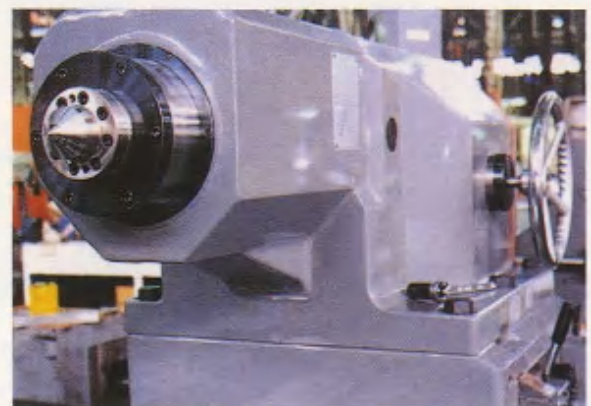

Tailstock

Figure Drawing

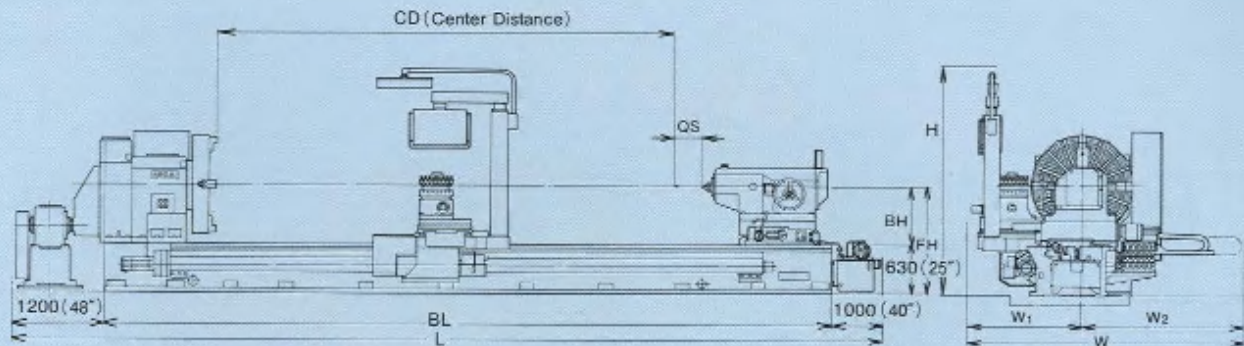

Main Dimensions

	ANC75	ANC100
H	3000mm(120")	3000mm(120")
FH	1380mm(55")	1630mm(65")
BH	750mm(30")	1000mm(40")
L	CD + 5450mm (CD + 215")	CD + 6250mm (CD + 246")
BL	CD + 3550mm (CD + 140")	CD + 4350mm (CD + 171")
QS	350mm(14")	400mm(16")
W	3500mm(140")	4000mm(160")
W ₁	1500mm(60")	1700mm(68")
W ₂	2000mm(80")	2300mm(92")

High Precision CNC LATHE With a Rigid Two-Guideway Bed

- The spindle gear box is mounted outside the headstock to avoid heat transmission.
- Pitch diameter of the drive gear is almost the same as the swing over carriage. A very rigid and strong headstock structure makes extremely smooth roughing and Interrupting cutting.
- The tailstock body movement can be operated by push-buttons, and the quill can be moved manually by a handle.
- The cross slide width is the largest in it's class.
- The bed guideways and saddle guideways are made of special casting and are hardened and ground.
- A spindle inching button is provided as a standard feature on the side of the headstock. It is absolutely necessary for loading and unloading purposes.

TNC 100 CNC LATHE

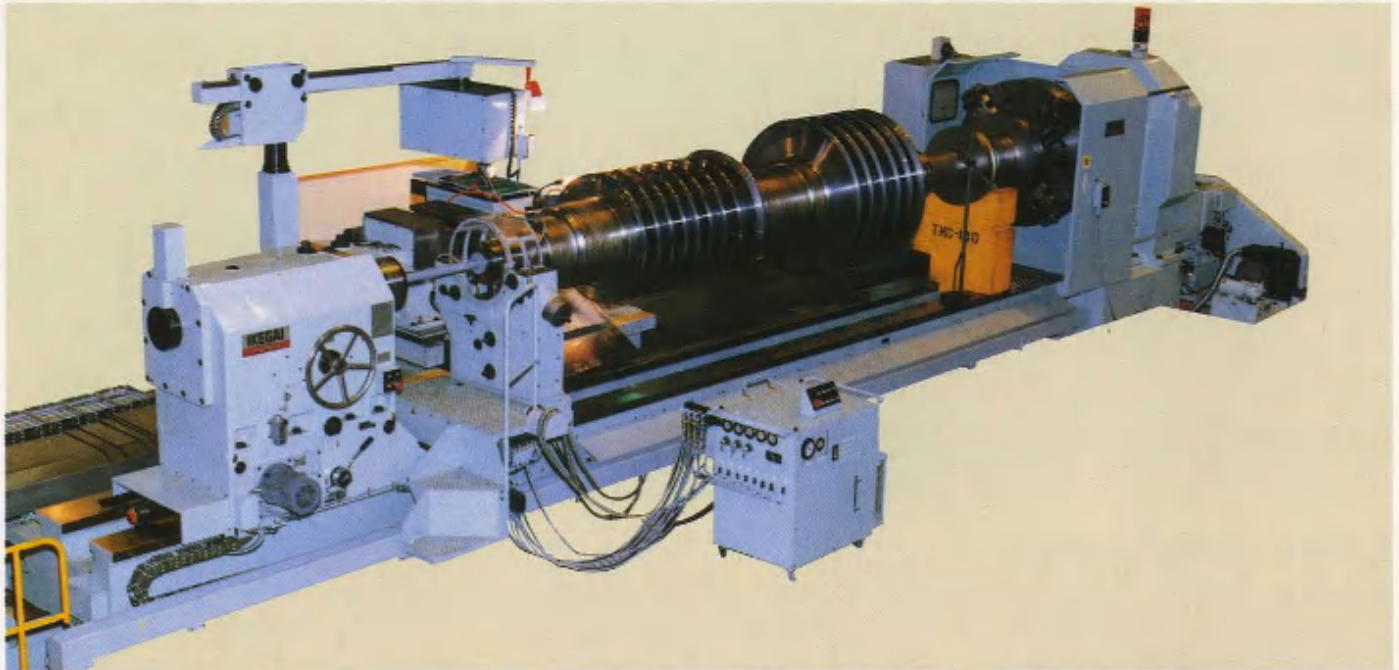

Main Spindle Torque Diagram

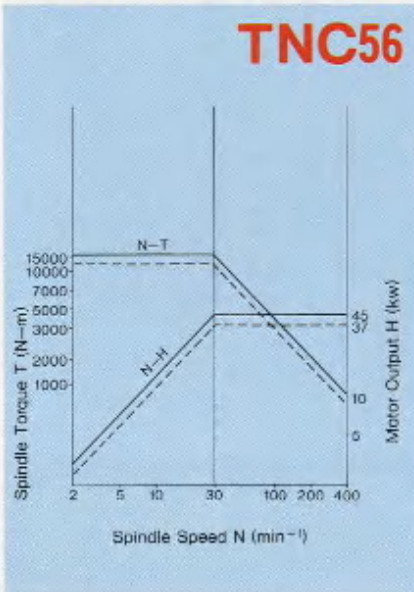

Main Spindle Torque Diagram

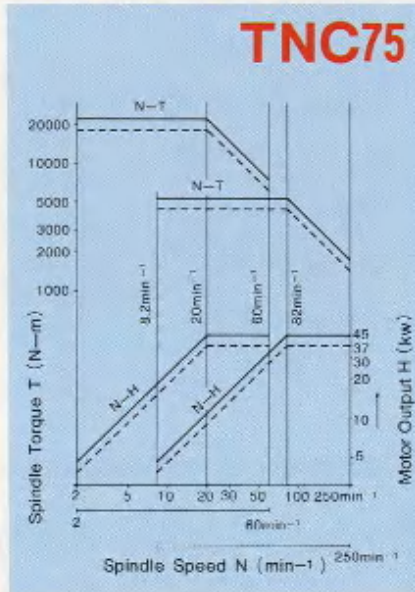

Main Spindle Torque Diagram

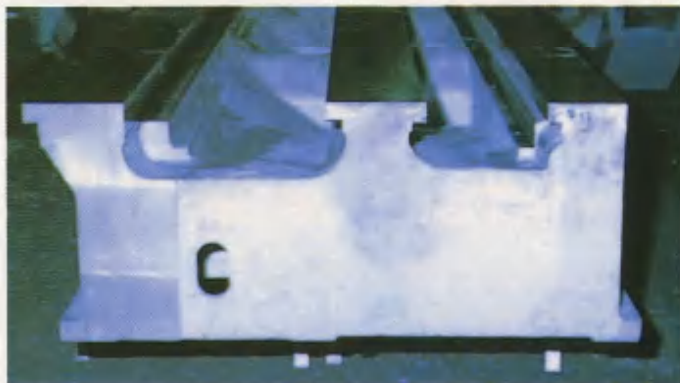
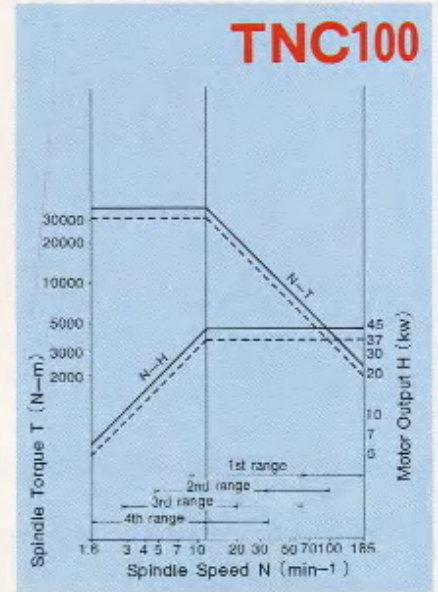

Bed With 3 Guideways



From Operator Side

Figure Drawing

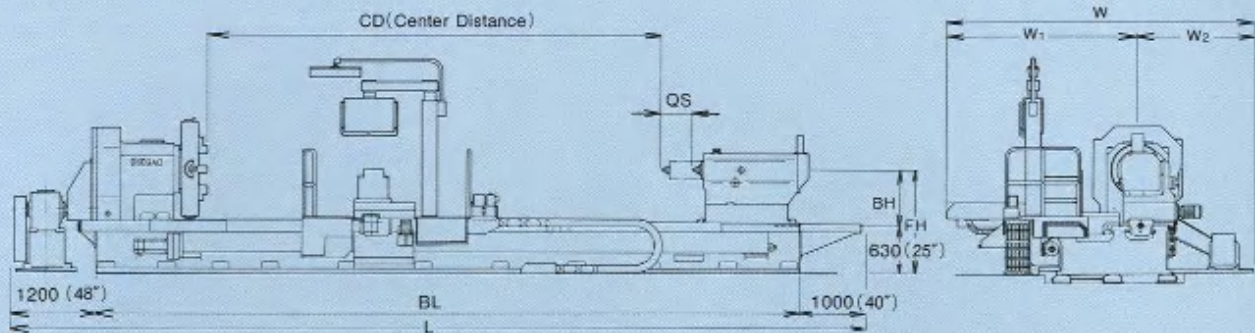

Main Dimensions

	TNC56	TNC75	TNC100
BH	610mm(24")	750mm(30")	1000mm(40")
FH	1240mm(49")	1380mm(55")	1630mm(65")
L	CD + 4900mm (CD + 193")	CD + 5700mm (CD + 224")	CD + 6300mm (CD + 248")
BL	CD + 2700mm (CD + 106")	CD + 3500mm (CD + 138")	CD + 4100mm (CD + 162")
QS	250mm(10")	350mm(14")	400mm(16")
W	3700mm(148")	4100mm(164")	4450mm(178")
W ₁	2100mm(84")	2500mm(100")	2750mm(110")
W ₂	1600mm(64")	1600mm(64")	1700mm(68")

High Precision CNC LATHE With a Rigid Three-Guideway Bed

- The spindle gear box is mounted outside the headstock to avoid heat transmission.
- Pitch diameter of the drive gear is almost the same as the swing over carriage. A very rigid and strong headstock structure makes extremely smooth roughing and Interrupting cutting.
- The tailstock body movement can be operated by push-buttons, and the quill can be moved manually by a handle.
- The cross slide width is the largest in it's class.
- The bed guideways and saddle guideways are made of special casting and are hardened and ground.
- A Spindle inching button is provided as a standard.

TNC56 TURNING CENTER

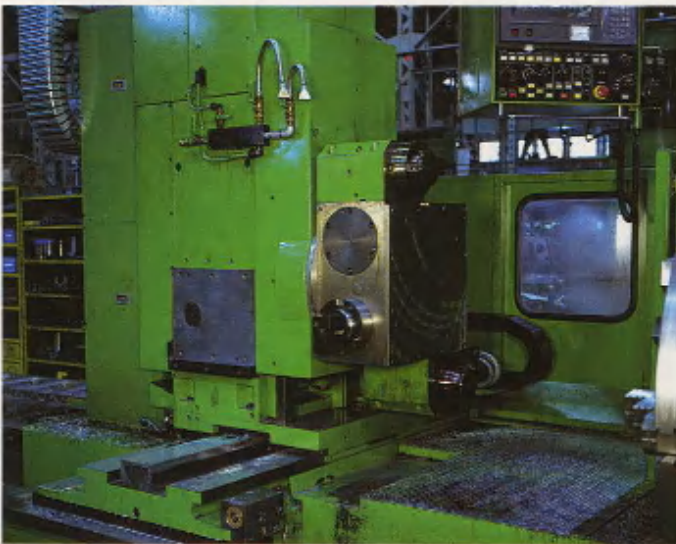
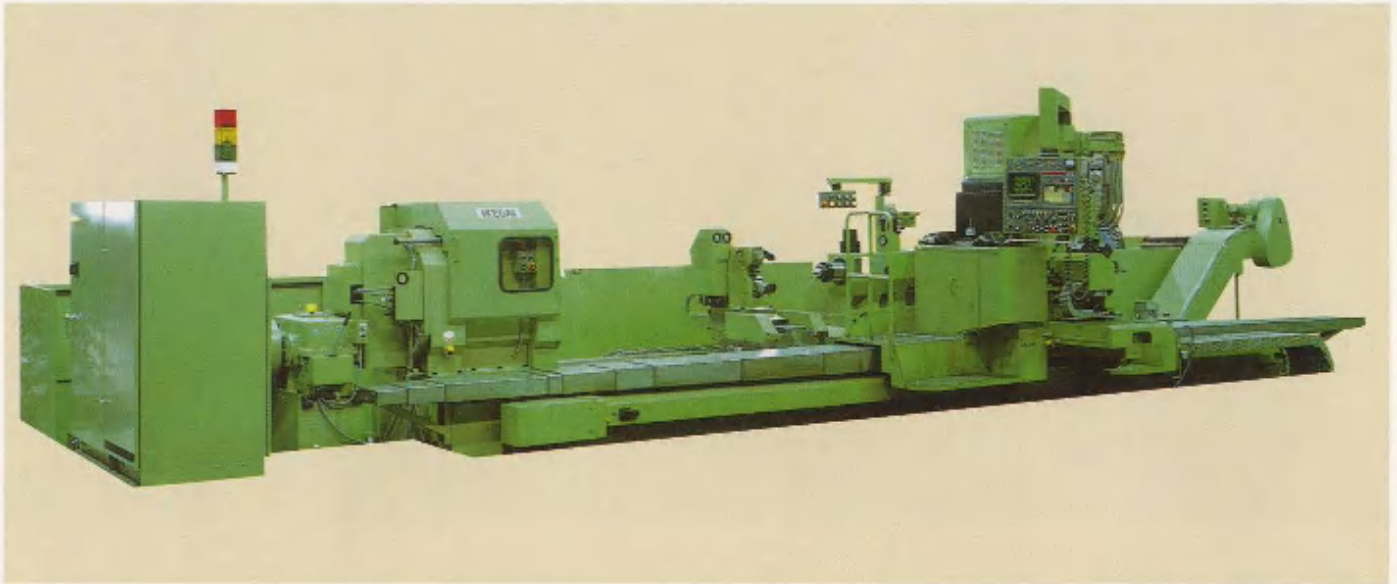

Turret with Y Axis

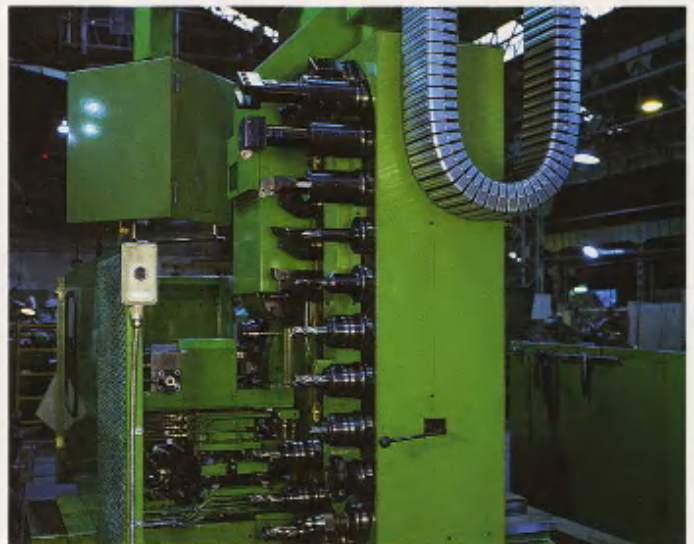

ATC

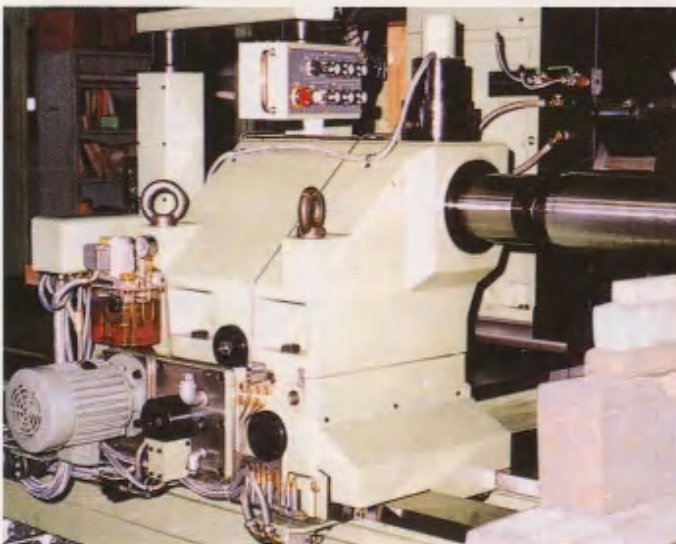

Programmable tailstock

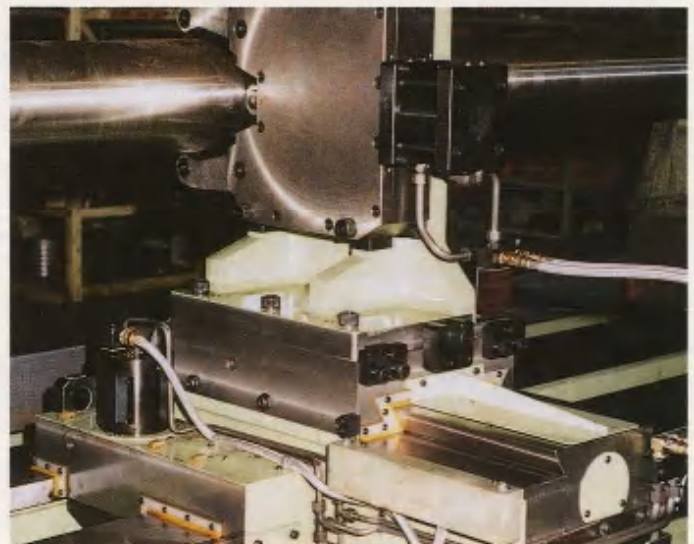

Auto. centering steady rest

Figure Drawing

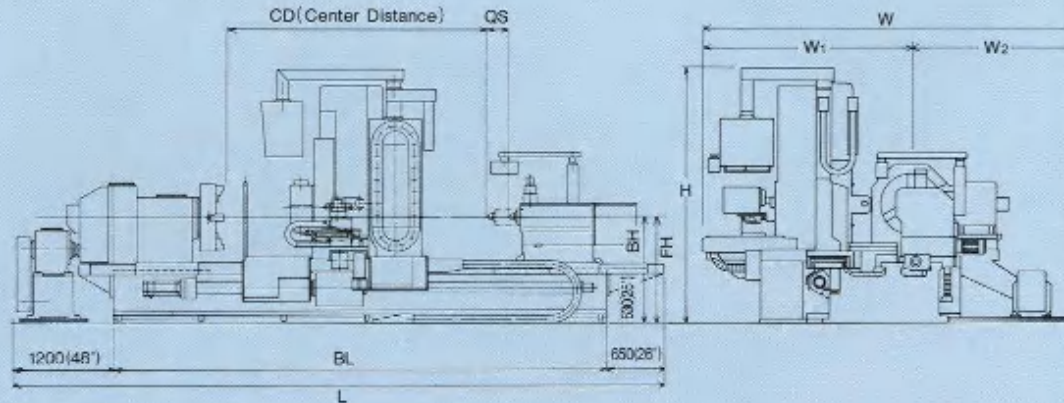

Specifications

	TNC56	TNC75
CENTER HEIGHT OVER BED mm(°)	610(24)	750(30)
SWING OVER CARRIAGE mm(°)	840(33°)	1200(47¼°)
CAPACITY		
Max. supportable weight between centers kg(lbs)	7000(15400)	15000(33000)
Max. cutting force kg(lbs)	2000(4420)	2000(4400)
Max. main spindle torque N-m	12,740	21000
MAIN SPINDLE		
Spindle nose	JIS A2 NO. 15	JIS A2 NO. 20
Spindle dia. mm(°)	240(9½°)	280(11°)
Spindle taper hole mm(°)	φ 80 (3¼) Taper 1/10	φ 100(4) Taper 1/10
Spindle speed range (Infinitely variable) min ⁻¹	2 Ranges 4-400	2 Ranges 2.5-250
REVOLVING TOOL SPINDLE		
Spindle nose	No.10 Short taper	BT. NO. 50
Spindle speed range min ⁻¹	80-1000	80-800
Tool change	ATC	ATC
CHUCK	φ810(32) 4 Jaw Independent	φ 1250(49¼) 4 Jaw Independent
BED		
No. of guideways	3	3
Width x height mm(°)	1200×630(48×24½)	1500×630(66×24½)
TRAVEL DISTANCE		
X axis mm(°)	500(20°)	560(22°)
Z axis mm(°)	C. D.+200(8)	C. D.+200(8)
Y axis mm(°)	+250, -150	+150(+8)-100(-4)
MAIN SPINDLE INDEXING	Every 3° or 0.001°	Every 3° or 0.001°
TAILSTOCK		
Type	Built-in quill programmable	Built-in quill, Self-movement
Quill dia. x stroke mm(°)	φ230×250(9×10)	260×350(10¼×14)
Spindle nose taper	MT. NO. 6	φ80(3¼) Taper 1/10
TURRET		
Type	4 Stations auto. index	8 Stations auto. index
Turning tool change	ATC	manually
ATC		
Storageable no.	24 Tools, turning tool	16 Tools, Revolving tool
Tool shank size	NT. NO. 50	BT. NO. 50
MAIN SPINDLE MOTOR OUTPUT kw(HP)	AC 1½(AC 10/20)	AC 37/45(AC 50/80)
REVOLVING TOOL SPINDLE MOTOR OUTPUT kw(HP)	AC 5.5/7.5(AC 7.5/10)	AC 5.5/7.5(AC 7.5/10)
CNC UNIT	FANUC-16TA CAP II	FANUC-15T
MACHINE WEIGHT kg(lbs)	25500/C.D.3m(48400/C.D.160)	32000/C. D. 4m(70400/C. D. 160)

Main Dimensions

MARK	MODEL	TNC56	TNC75
H		3000mm(118°)	3300mm(132°)
FH		1240mm(49°)	1830mm(55°)
BH		610mm(24°)	750mm(30°)
L		CD+4650mm(CD+183°)	CD+5400mm(CD+216°)
BL		CD+2500mm(CD+98°)	CD+3200mm(CD+128°)
QS		250mm(10°)	350mm(14°)
W		3500mm(138°)	4100mm(164°)
W ₁		2000mm(79°)	2500mm(100°)
W ₂		1500mm(59°)	1600mm(64°)

Major Functions

1. Main spindle auto. index
2. Turret with Y axis
3. Programmable tailstock
4. ATC
5. Auto. centering steady rest
6. FBG
7. Tool setter (Touch sensor type)

TNC100S CNC LATHE

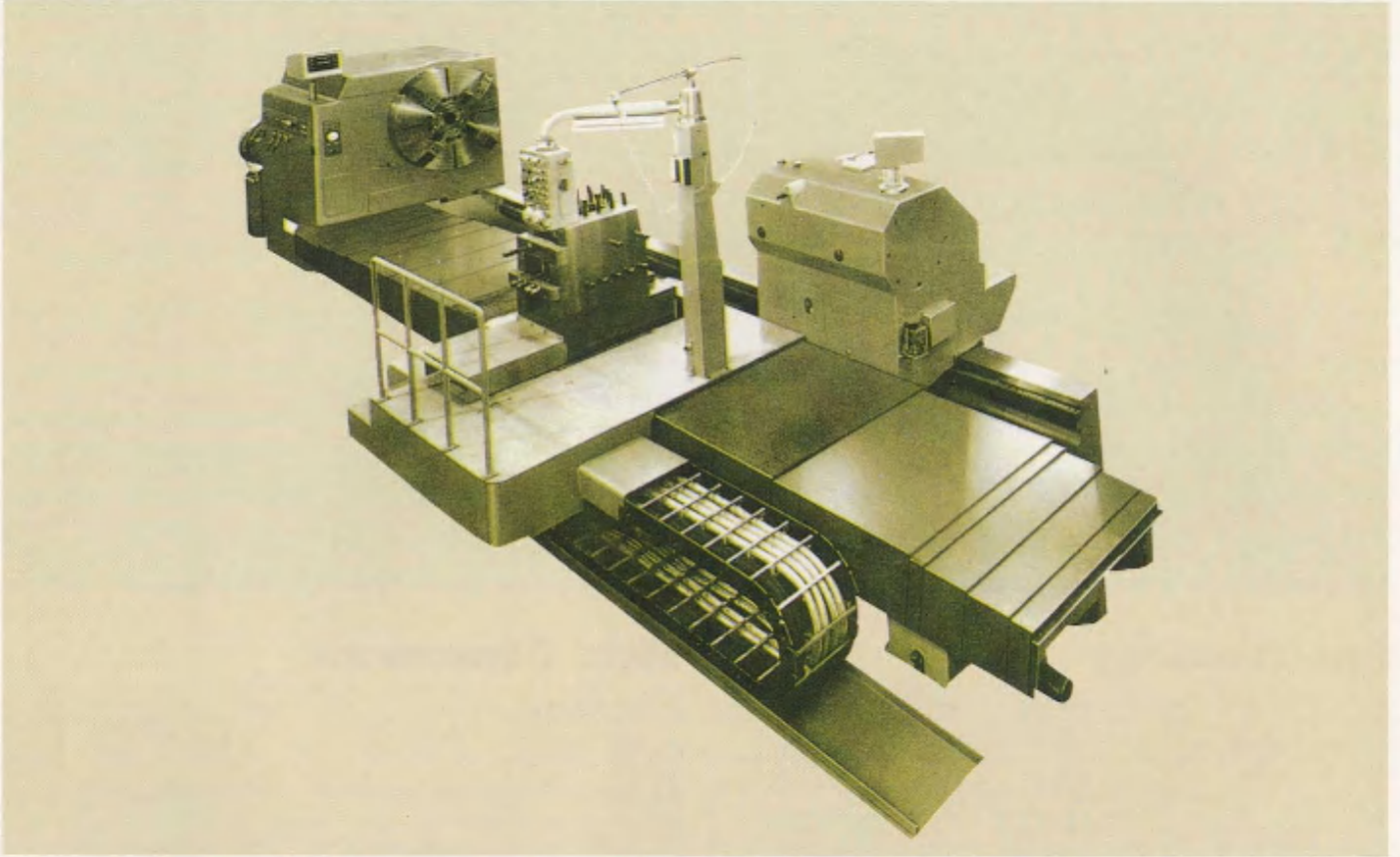

TNC125S CNC LATHE

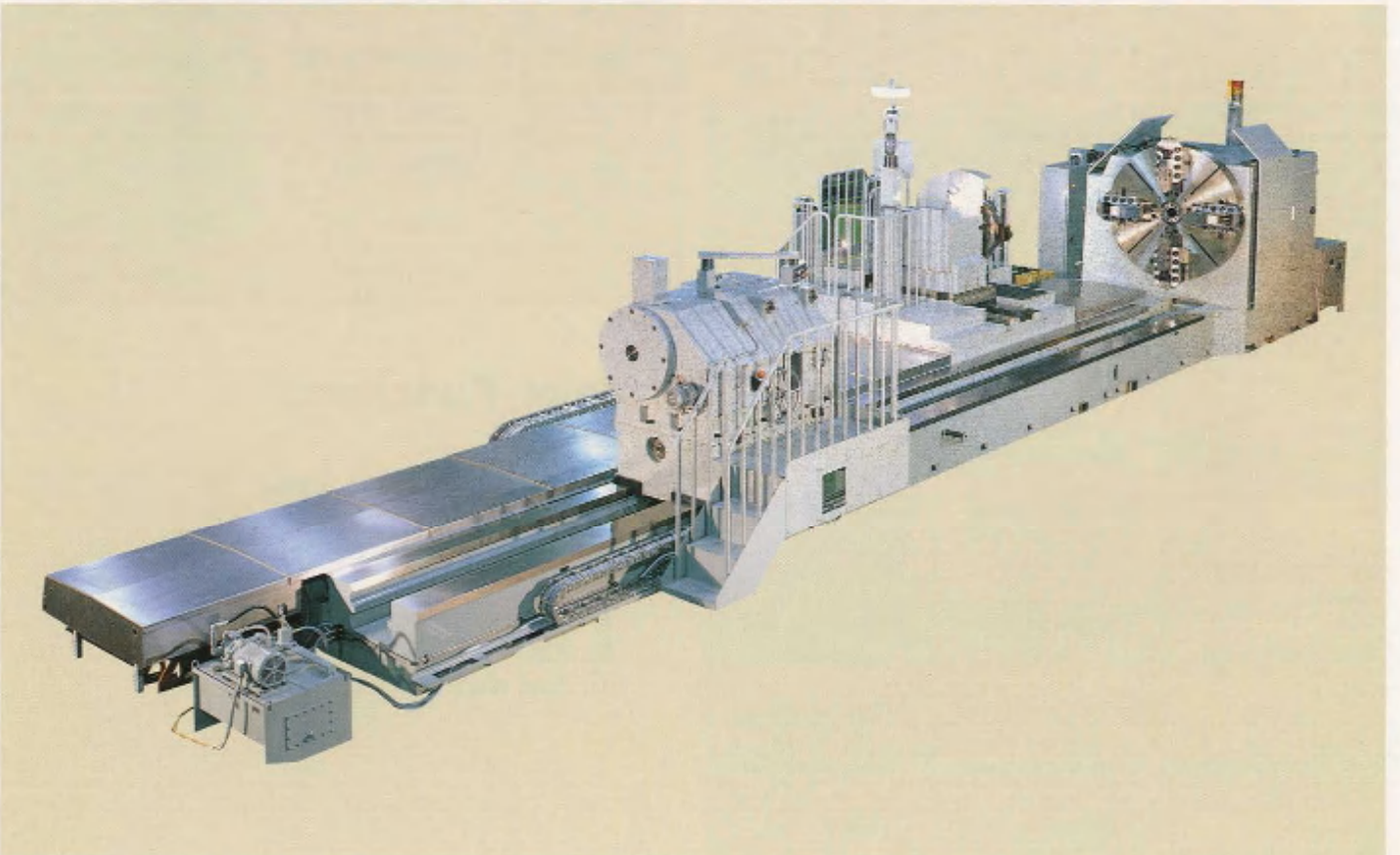

Heavy Duty CNC LATHE With 4 Guideways Bed, TNC100S · TNC125S

Figure Drawing

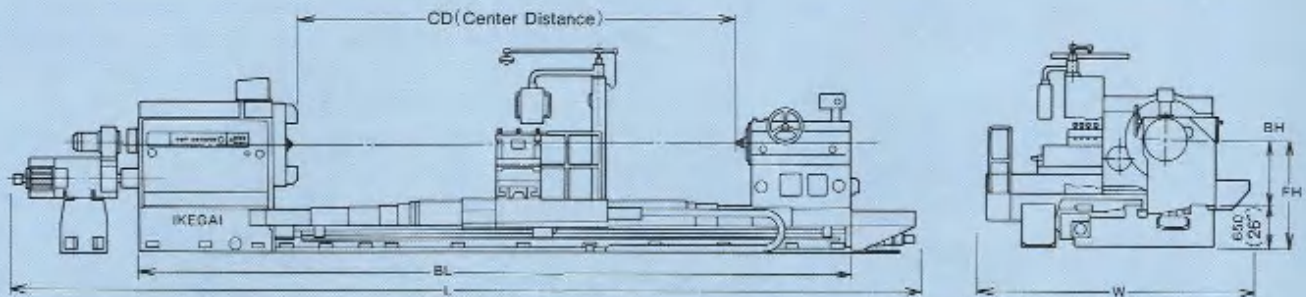

Main Specifications

	TNC100S	TNC125S
MAIN SPINDLE		
Front bearing dia. mm(°)	440(17 ^{3/8})	530(20 ^{7/8})
Rear bearing dia. mm(°)	300(11 ^{13/16})	340(13 ^{3/8})
Taper hole	φ 140(5 ^{1/2}) Taper 1/10	
Center height over bed mm(°)	1000(40)	1250(50)
Spindle speed range (Infinitely variable) min ⁻¹	3 ranges 2~100	3 ranges 1.5~100
TAILSTOCK		
Quill dia. mm(°)	480(18 ^{29/32})	580(22 ^{27/32})
Spindle dia. mm(°)	280(11)	340(13 ^{3/8})
Taper hole	φ 140(5 ^{1/2}) Taper 1/10	
Quill stroke mm(°)	450(18)	500(20)
CARRIAGE		
Width of carriage mm(°)	1520(59 ^{27/32})	1700(66 ^{15/16})
Width of crossslide mm(°)	450(18)	500(20)
Z axis stroke mm(°)	C. D. +150(C. D. +6)	
X axis stroke mm(°)	650(26)	770(30 ^{3/8})
BED		
Width mm(°)	2000(80)	2500(100)
Height mm(°)	650(26)	
No. of guideways	4	
RAPID TRAVERSE		
Z axis mm/min(°/min)	4800(192)	
X axis mm/min(°/min)	2400(96)	
Tailstock	50HZ	2000(80)
	60HZ	2400(96)
MOTOR OUTPUT		
Main spindle motor kw(HP)	DC75(DC100)	DC110KW(DC145)
Z axis motor	AC MODEL α65(8.2kw)	
X axis motor	AC MODEL α100(10kw)	
Tailstock motor kw(HP)	AC1.5(2)	AC2.2(3)
Lubrication motor kw(HP)	AC1.5(2)	
CAPACITY		
Swing over carriage mm(°)	1600(64)	2100
Supportable weight between centers kg(lbs)	50000(110000)	70000(154000)
Main spindle torque N-m	63000	100000
Max. cutting force kg(lbs)	8000(17600)	10000(22000)
MACHINE WEIGHT		
C. D. 6000mm(240°) kg(lbs)	90500(199100)	125000(275000)
C. D. 7000mm(280°) kg(lbs)	94300(207460)	133000(292600)
C. D. 8000mm(320°) kg(lbs)	98100(215820)	141000(310200)
C. D. 10000mm(400°) kg(lbs)	105700(232540)	161000(354200)

Main Dimensions

	TNC100S	TNC125S
FH	1650mm(66°)	1900mm(76°)
BH	1000mm(40°)	1250mm(50°)
L	CD+7000mm(CD+280°)	CD+8100mm(CD+324°)
BL	CD+4200mm(CD+168°)	CD+5300mm(CD+212°)
W	4300mm(172°)	4800mm(192°)

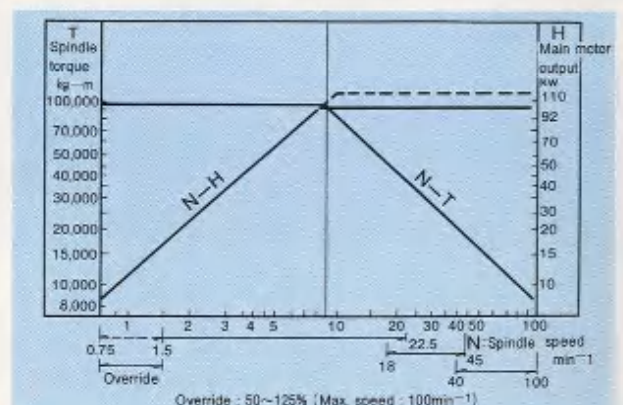
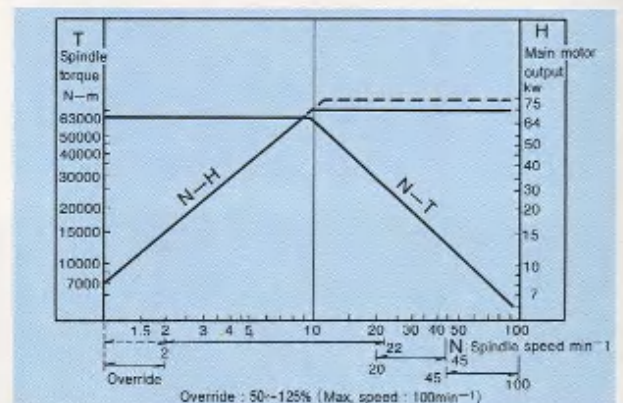

Characteristics of ANC. TNC Series

Headstock

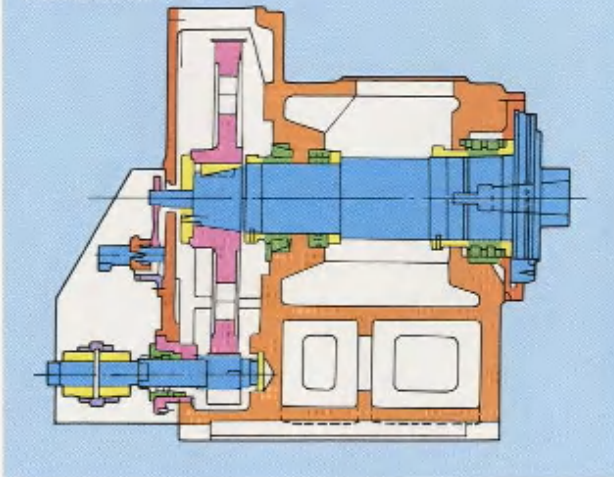

1. The Spindle gear box is mounted outside the headstock. This results in no heat distortion between the front and rear of the spindle as only one large diameter spindle is in the headstock.
2. The main spindle is supported at two points and is a "rear driven system".
3. The large diameter of the helical gear provides no backlash, smooth spindle rotation and very heavy duty machining, even when interrupting cutting.
4. Constant surface speed control is a standard feature.

Tailstock

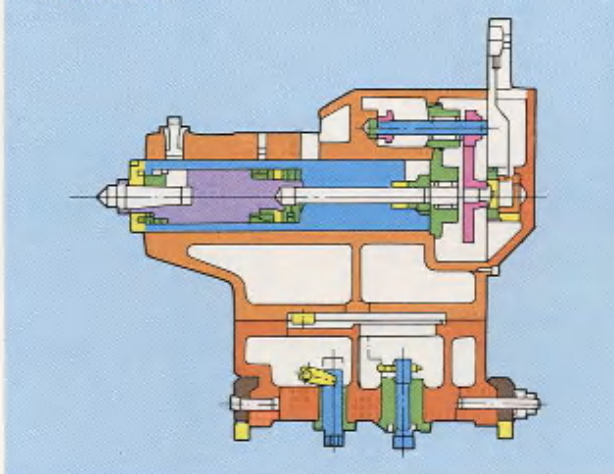

1. The body is clamped firmly on the bed by wedge type plates and jaws which prevent it from reversing.
2. Thrust force can be monitored by a meter on the tailstock.
3. The tailstock body can be operated either by a simple push-button operation, or manually with a handle for adjustment.

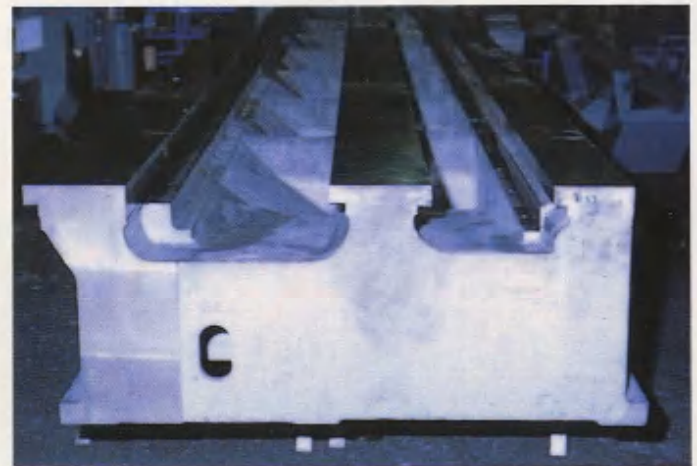
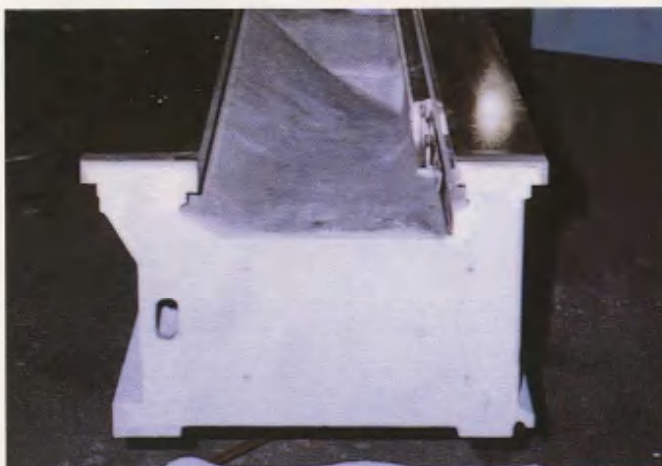

1. Cutting force is always inside the guideways. Cutting force per cm^2 (inch^2) will be minimal as guideways are so wide.
2. Guideways are all hardened and ground.
3. Guideways are rectangular shaped. Saddle is guided at four faces (front & rear, right & left).

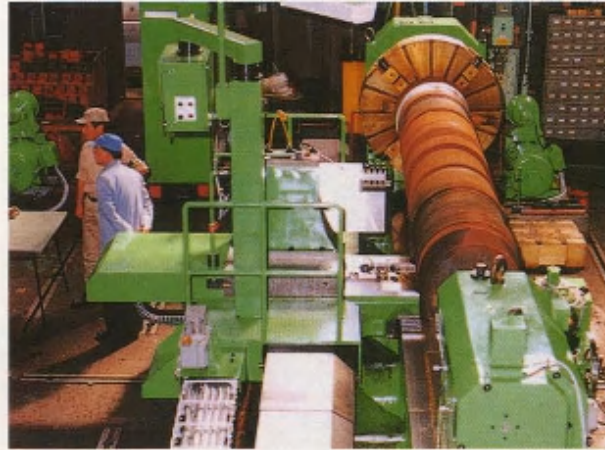

Double Anchor (Up to center distance 7000mm)

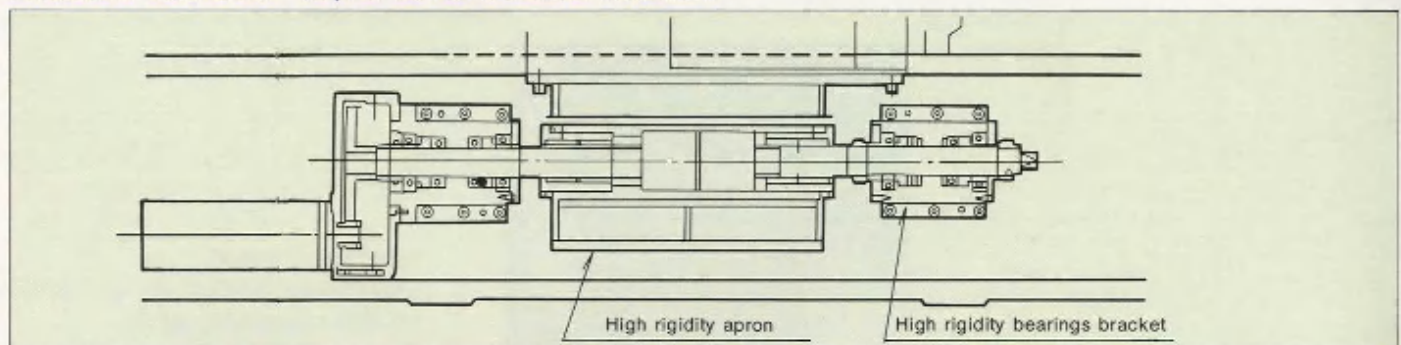

Double Pinion (Center distance longer than 8000mm)

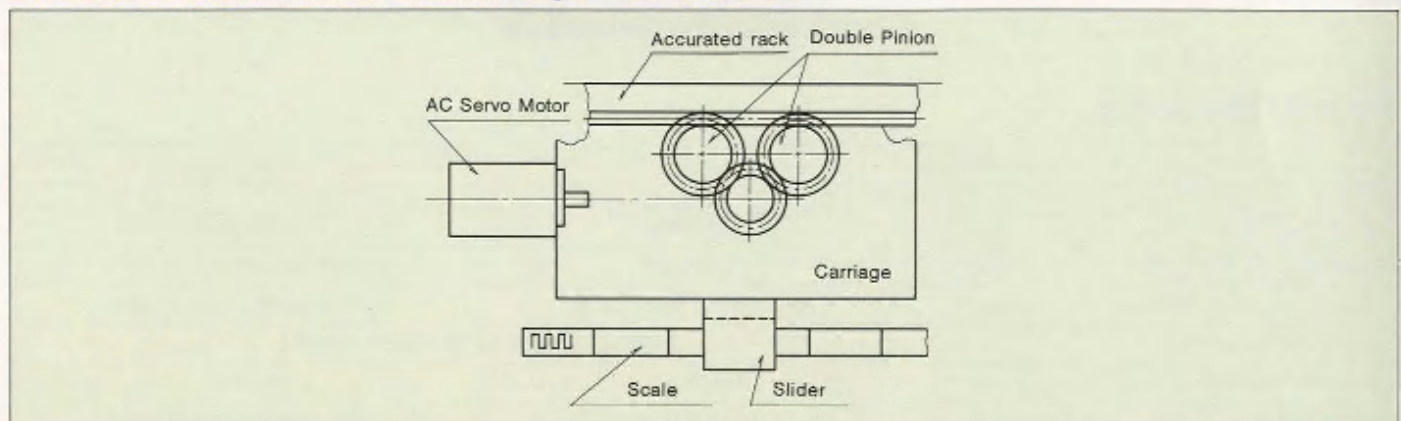

1. Guideways are rectangular shaped. Saddle is guided at four faces for smooth movement with the least lost motion.
2. Guideways on saddle and cross slide are hardened and ground.
3. Thick and wide supporting face and span provides a very high and strong rigidity against deforming.
4. Large diameter ball screws on X-axis and Z-axis are preloaded and supported at both ends to prevent thermal and elastic distortion.

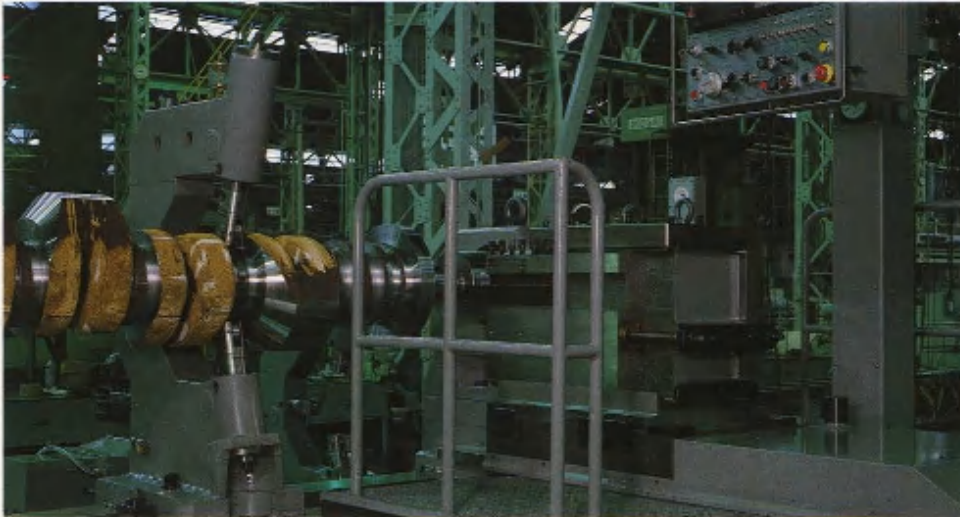

Control step:
Machine can be operated
on the saddle.



Operation panel:
Machining operation is centralized
on this operation panel.

Specifications

Item	NC Unit	18 T	16CAPII
Controlled axis		X, Z(2 Axes)	X, Z(2 Axes)
Least input increment	mm(°)	0.001(0.0001)	0.01/0.001(0.001/0.0001)
Max. commandable value	mm(°)	±99999.999(±9999.9999)	±99999.999(±9999.9999)
Absolute/Incremental		Combined Use In The Same Block	
Decimal point input		Possible	Possible
Cutting feed	mm/rev(°/rev)	0.001~500.000(0.0001~9)	0.001~500.000(0.0001~9)
Handle feed	mm(°)	0.001/0.01/0.1(0.0001/0.001/0.01)	0.001/0.01/0.1(0.0001/0.001/0.01)
Rapid traverse override	%	FL,25,50,100	FL,25,50,100
Cutting feed override	%	0-150	0-150
Part program storage length	m	20	40
Spindle function		S4 Digit	S4 Digit
Constant surface speed control		G96 Command	G96 Command
Tool function		T4 Digit	T4 Digit
Tool offset		16 Pairs	32 Pairs
Registered programs		63	100
Canned cycle		G90, G92, G94	G90, G92, G94
CRT		9" Mono Chrome	14" Color
Memory type pitch error compensation		Standard	Standard
Back ground editing		Standard	Standard

TNC100RS

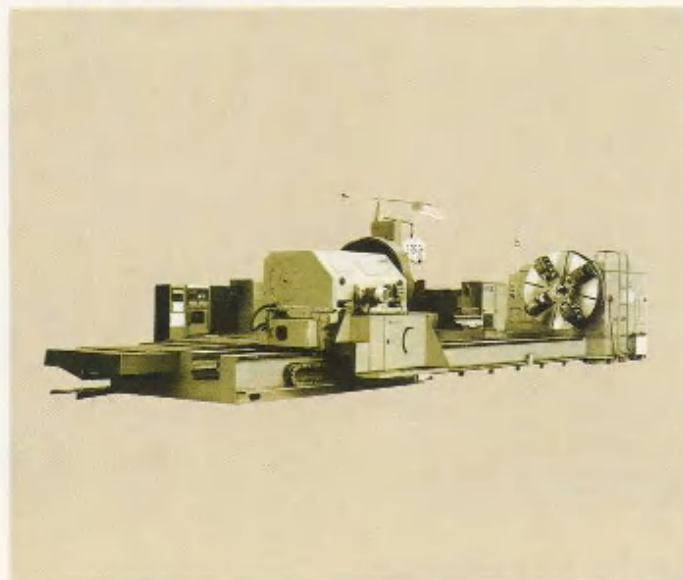

TRS125

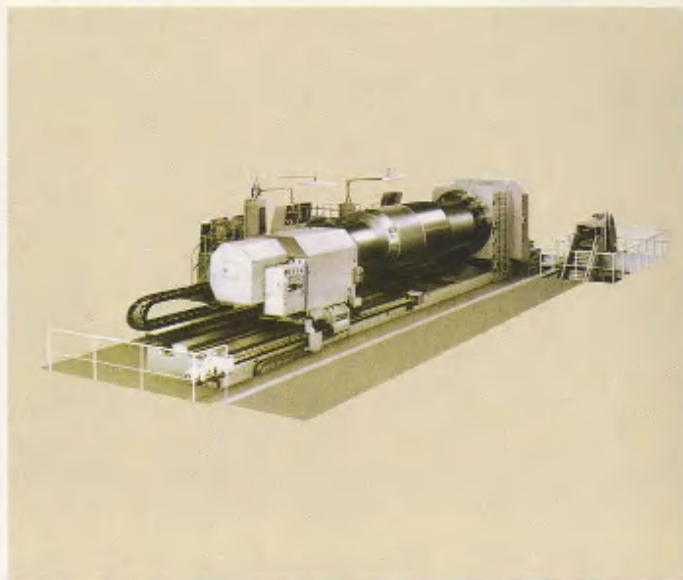

Specifications TNC100RS

		TNC100RS
MAIN SPINDLE		
Front bearing dia.		600mm(24")
Rear bearing dia.		340mm(13 ³ / ₈ ")
Taper hole		φ 140 Taper 1/10(5 ¹ / ₂ Taper ¹ / ₁₀)
Center height over bed		1000mm(40")
Spindle speed range (Infinitely variable)		3 Ranges 1.0~100min ⁻¹
TAILSTOCK		
Spindle dia.		440mm(17 ⁵ / ₁₆ ")
Taper hole		φ 140Taper1/10(5 ¹ / ₂ Taper ¹ / ₁₀)
CARRIAGE		
Width of carriage		1750mm(70")
Width of crossslide		800mm(32")
Z axis stroke		C.D. + 200mm(C.D. + 8")
X axis stroke		770mm(30 ⁵ / ₁₆ ")
BED		
Width of bed		2530mm(100")
Height of bed		650mm(25 ¹ / ₂ ")
No. of guideways		4
RAPID TRAVERSE		
Z axis		4800mm/min(192"/min)
X axis		2400mm/min(96"/min)
Tailstock	50Hz	2000mm/min(80"/min)
	60Hz	2400mm/min(96"/min)
MOTOR OUTPUT		
Main spindle motor		DC 220kw(DC295HP)
Z axis motor		AC Model α 100(10kw)
X axis motor		AC Model α 150(12kw)
Tailstock motor		AC 2.2kw(AC 3 HP)
Lubrication motor		AC 1.5kw(AC 2 HP)
CAPACITY		
Swing over carriage		1600mm(64")
Supportable weight between centers		70000kg(154000lbs.)
Main spindle torque		120000N·m
Max. cutting force		20000kg(44000lbs.)
MACHINE WEIGHT		
C.D. 8000mm		139000kg(305800lbs.)
C.D. 10,000mm		147000kg(323400lbs.)

Specifications TRS125

		TRS125
MAIN SPINDLE		
Front bearing dia.		900mm(36")
Rear bearing dia.		710mm(28")
Taper hole		φ 160Taper1/4(6 ⁹ / ₃₂ Taper ¹ / ₄)
Center height over bed		1300mm(52")
Spindle speed range		1~20min ⁻¹
TAILSTOCK		
Spindle dia.		800mm(32")
Taper hole		φ 160Taper1/4(6 ⁹ / ₃₂ Taper ¹ / ₄)
Quill stroke		150mm(6")
CARRIAGE		
Width of carriage		2000mm(80")
Width of crossslide		1240mm(49")
Z axis stroke		C.D. + 200mm(C.D. + 8")
X axis stroke		700mm(28")
BED		
Width of bed		3500mm(140")
Height from floor		1000mm(40")
No. of guideways		4
RAPID TRAVERSE		
Z axis		3000mm/min(120"/min)
X axis		1500mm/min(60"/min)
Tailstock	50Hz	1200mm/min(48"/min)
	60Hz	1450mm/min(58"/min)
MOTOR OUTPUT		
Main spindle motor		DC 360kw(DC480HP)
Z axis motor		DC 1.5kw(DC 2HP)
Z axis rapid traverse motor		AC 4P 5.5kw(AC 4P 7.5HP)
X axis motor		DC 0.75kw(DC 1HP)
X axis rapid traverse motor		AC 2P 1.5kw(AC 2P 2HP)
Tailstock motor		AC 4P 5.5kw(AC 4P 7.5HP)
Headstock lubrication motor		AC 4P 1.5kw(AC 4P 2HP)
CAPACITY		
Swing over carriage		2000mm(80")
Supportable weight between centers		120000kg(264000lbs.)
Main spindle torque		400000N·m
Max. cutting force		32000kg(70400lbs.)
MACHINE WEIGHT		
C.D. 8000mm (320")		227000kg(499400lbs.)
C.D. 10,000mm (400")		240000kg(528000lbs.)

Example Of Heavy Cutting



TRS125 Example Of Rough Cutting

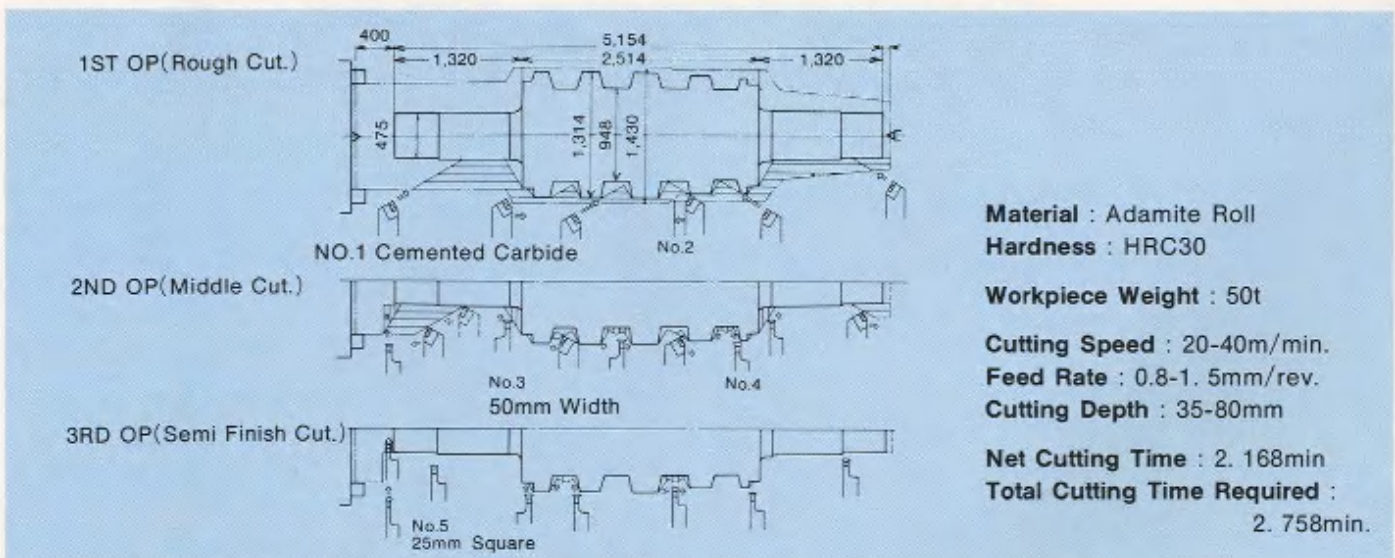

TNC125S Example Of Finish Cutting

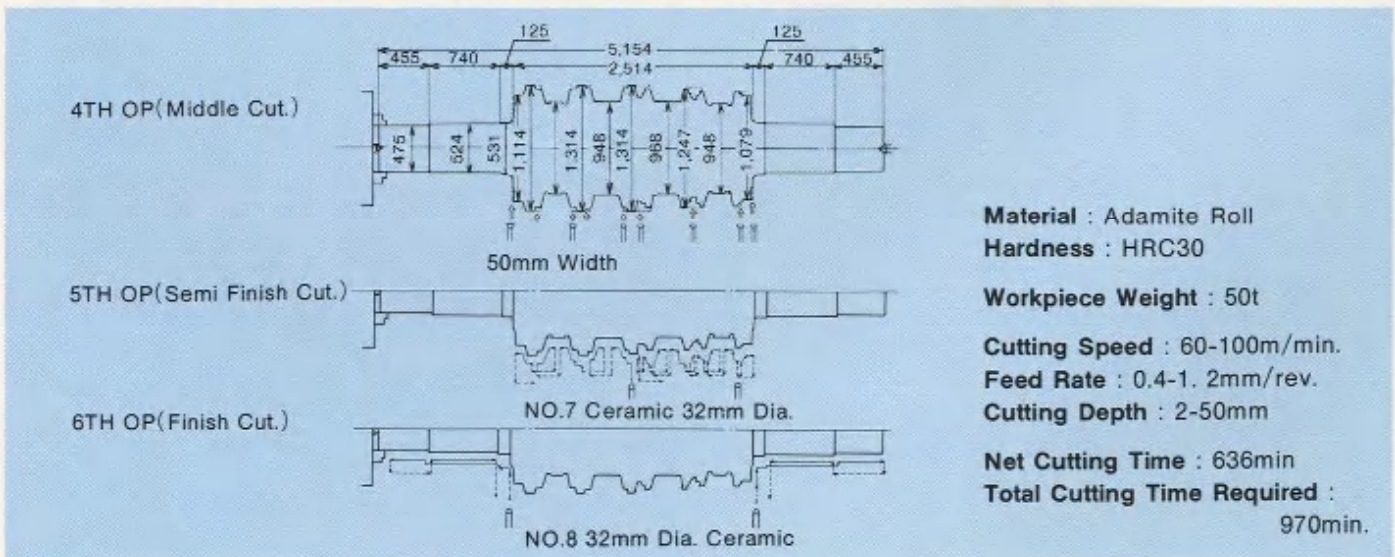

Example Of CNC Accuracy (TNC75 × 7000)

X Axis One Pulse Feed

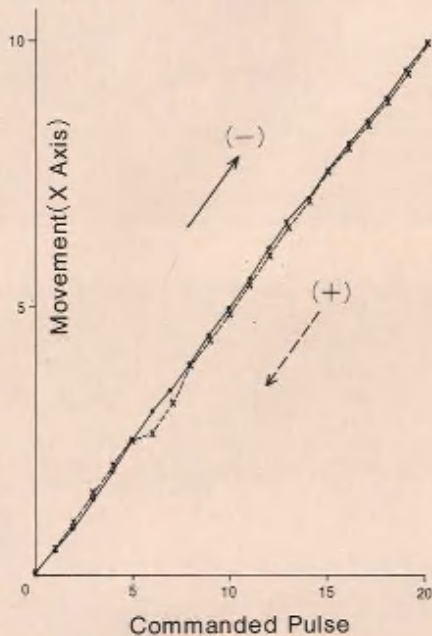

X Axis Positioning Accuracy

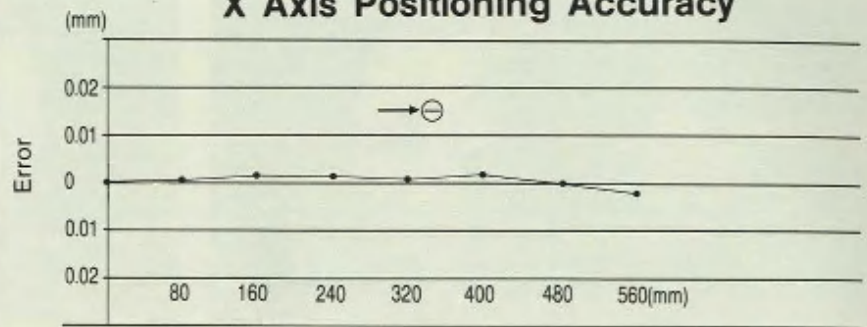

Z Axis Positioning Accuracy

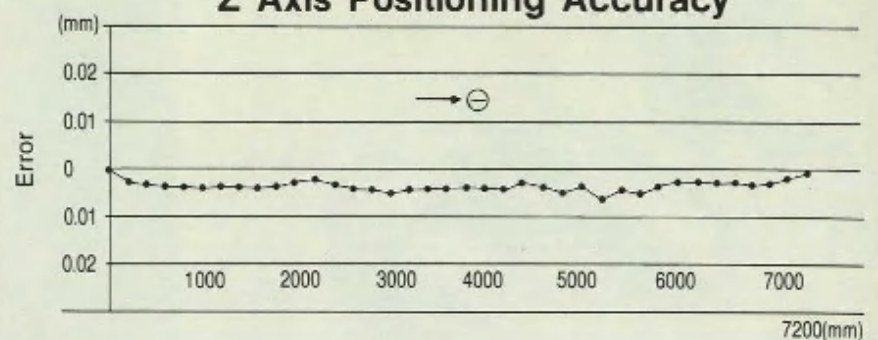

Example Of Machining Accuracy (TNC75 × 7000)

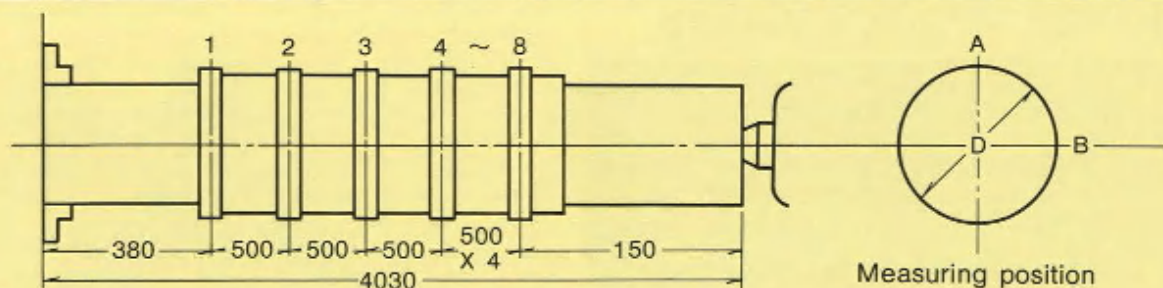

Cutting Conditions

Spindle Speed 180min⁻¹
 Cutting Speed 152m/min
 Cutting Depth 0.2mm
 Feed Rate 0.2mm/rev
 D = 271mm

Tool Used : P10
 Material : S45C

	1	2	3	4	5	6
A	271.595	.600	.610	.620	.620	.618
B	.600	.605	.615	.625	.625	.622
Roundness	0.005	0.005	0.005	0.005	0.005	0.004

7	8	9	10	11	12	Cylyndricity
.615	.610					0.025
.618	.613					0.025
0.003	0.003					

Standard Accessories



4 Jaw Chuck

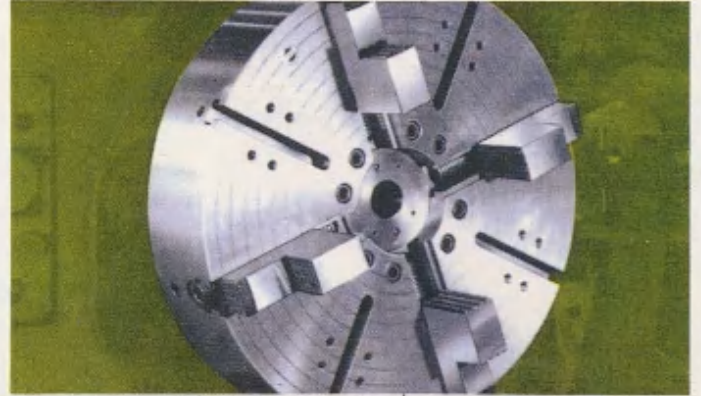

4 Jaw Chuck



Dead Center

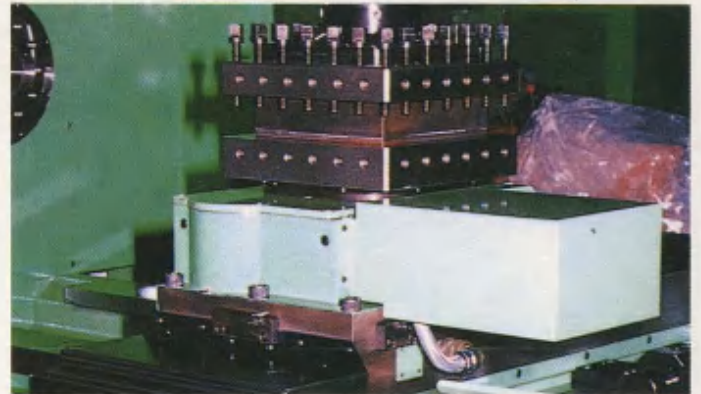

Square Turret

Optional Accessories

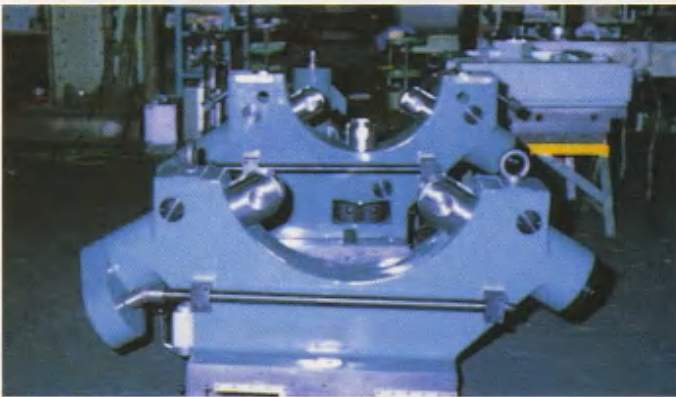

Steady Rest (Open Type)

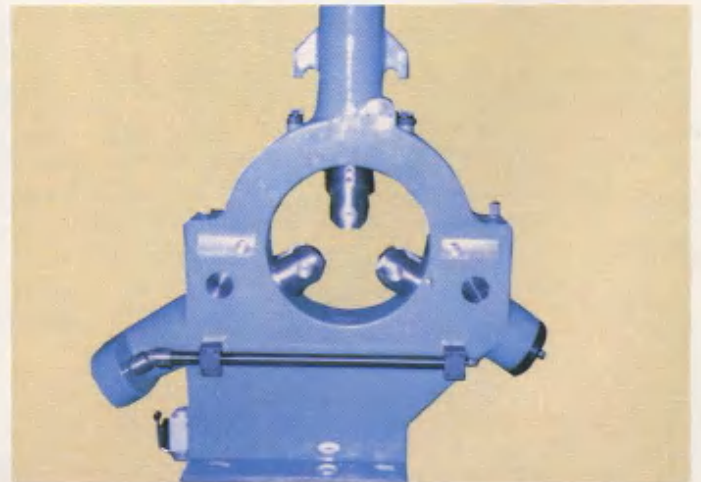

Steady Rest (Closed Type)



Steady Rest (Semi Closed Type)

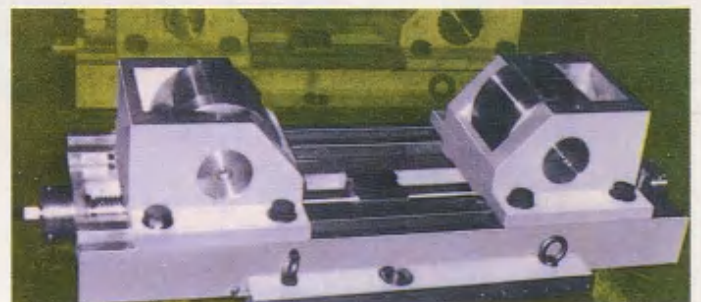

Roller Type Supporting Unit

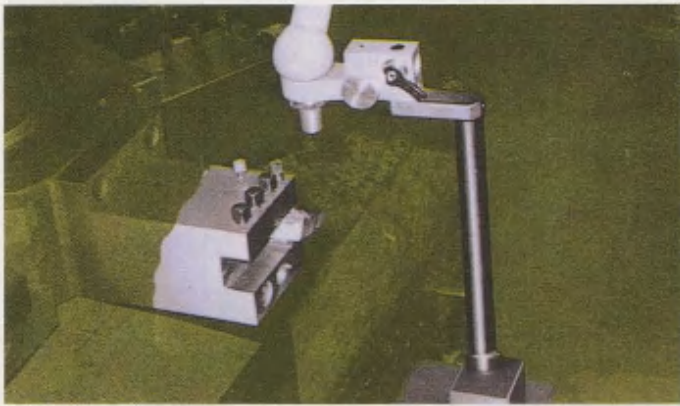

Tool Setting Gauge, Type IV

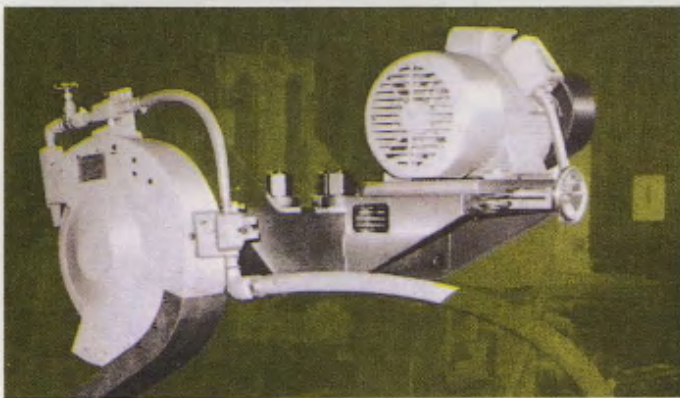

Grinding Attachment

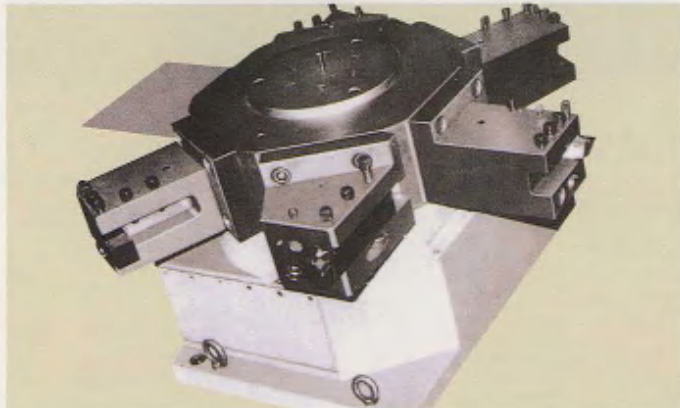

Hexagonal Turret

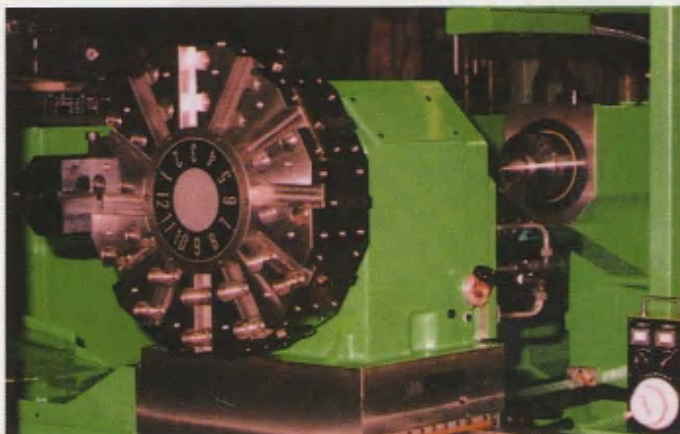

12 (8) Stations Turret

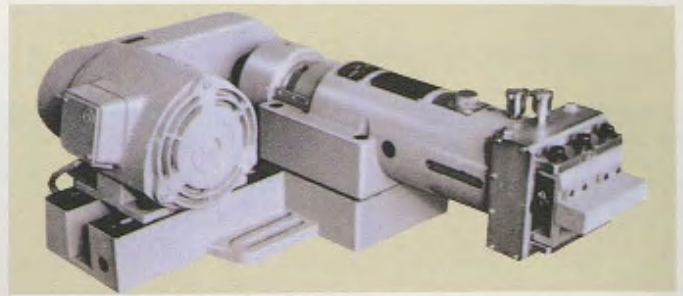

Super Finishing Attachment

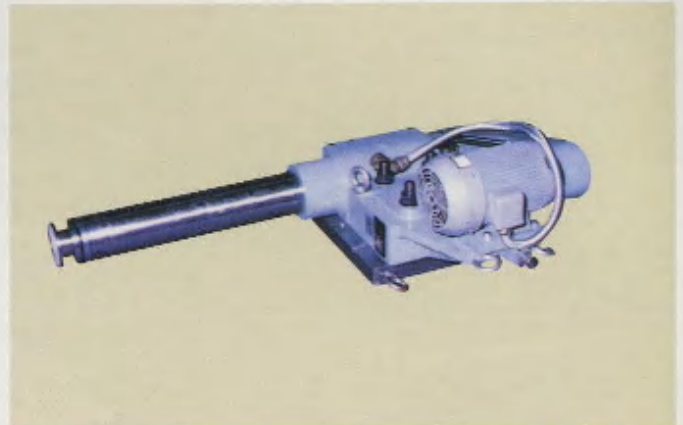

Internal Grinding Attachment



Chip Conveyor

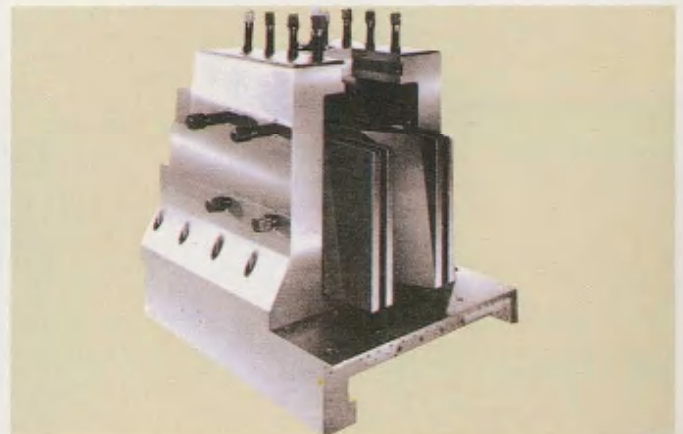

Stay Type Tool Post

Assembly Factory For Large Size CNC Lathe

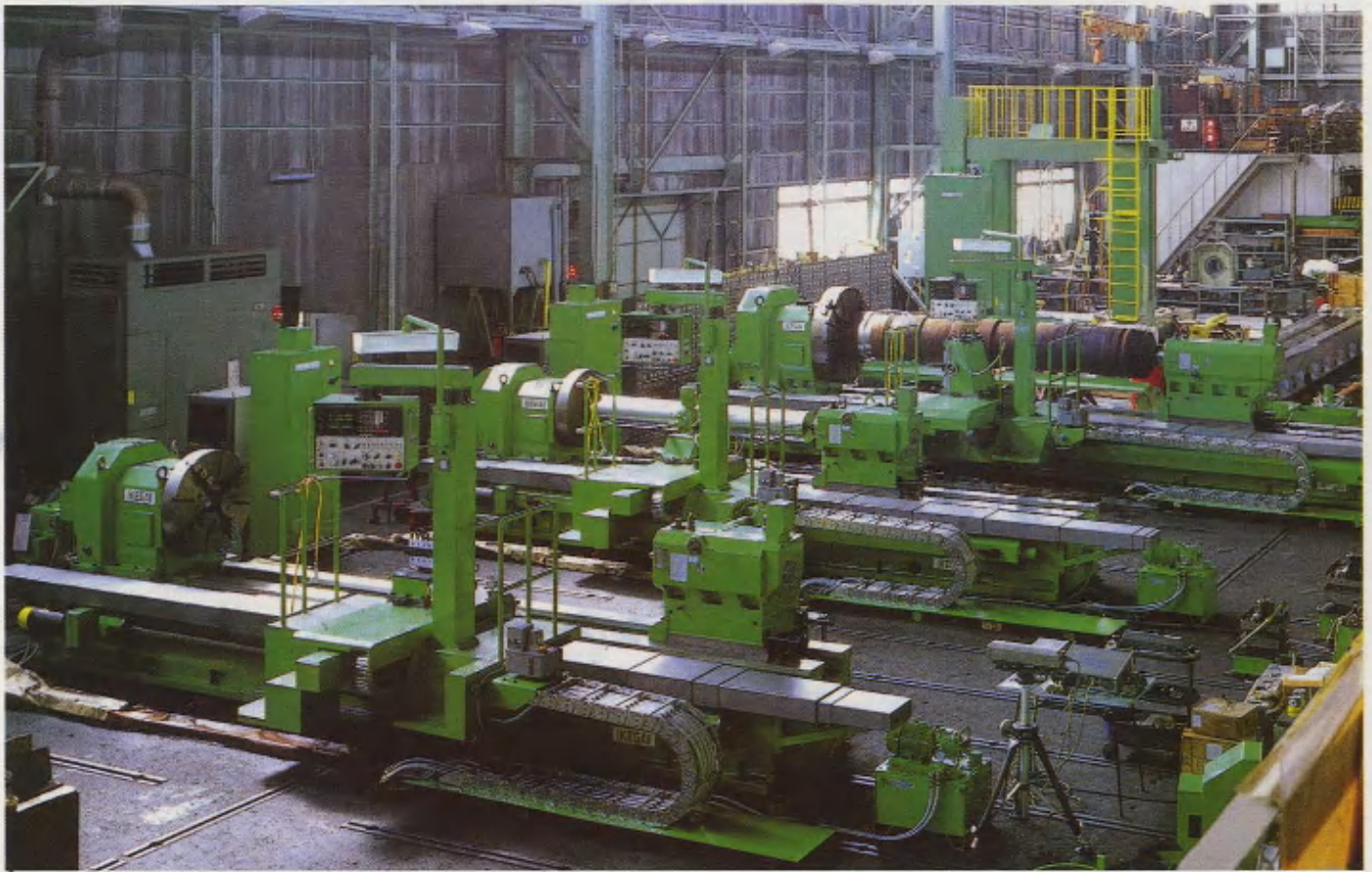

Home page address <http://www.ikegai.co.jp/>

DISTRIBUTED BY

IKEGAI CORPORATION

1-80 Shinmei-cho, Saiwai-ku, Kawasaki-shi,
Kanagawa 210-0922 JAPAN
Telephone:(044)544-3561 Facsimile:(044)544-3707

IKEGAI AMERIKA CORPORATION

100 High Grove Boulevard,
Glendale Heights, IL 60139-2279
Telephone:(630)924-8800 Facsimile:(630)924-8879

IKEGAI EUROPE GmbH

Im Taubental 54, D-41468 Neuss Germany
Telephone:+49(0)2131-35-521 Facsimile:+49(0)2131-33-802
E-mail: IKEGAI-EUROPE@t-online.de

Specifications are subject to change without notice.

This machine shall require you to recognize that it is a model under control of Japanese export management regulation.